

-'s

10



Emi's hair



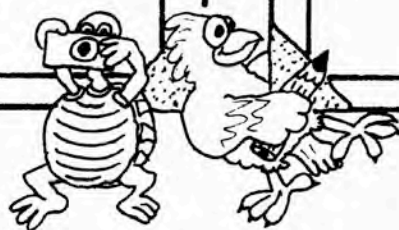
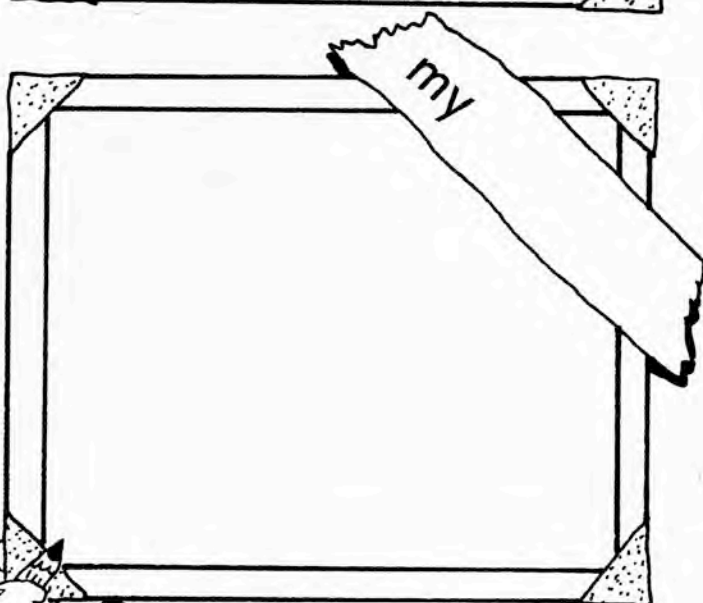
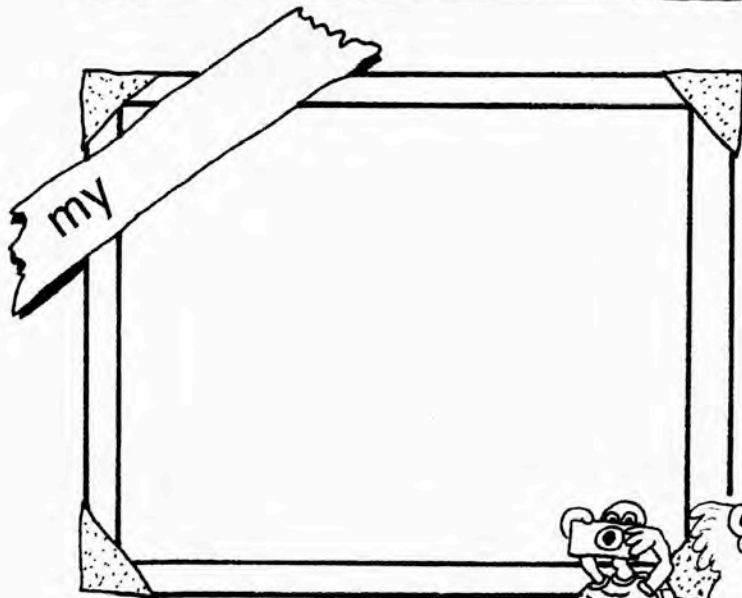
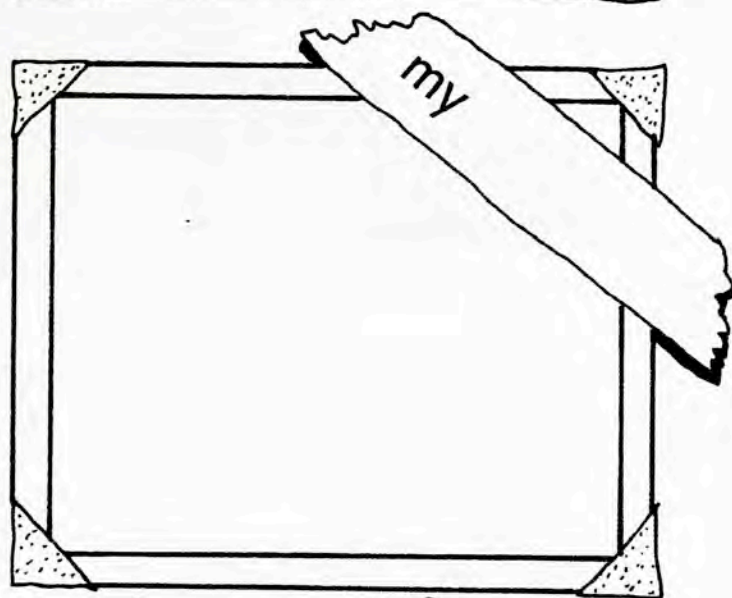
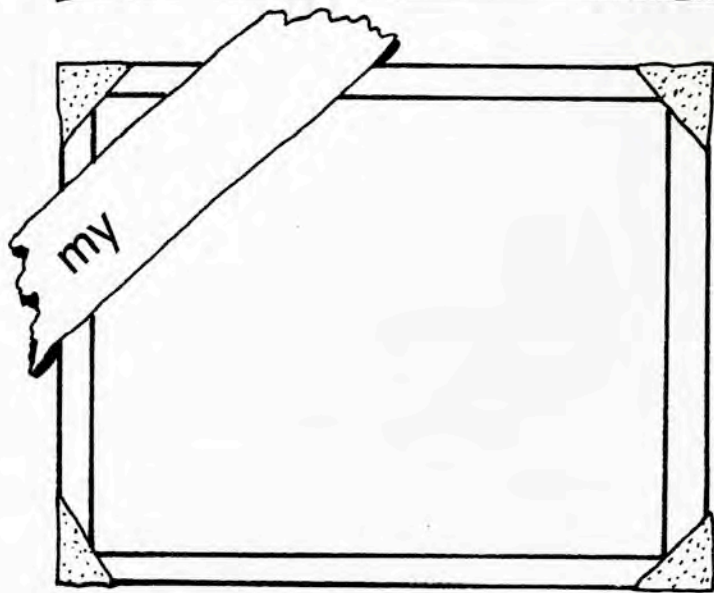
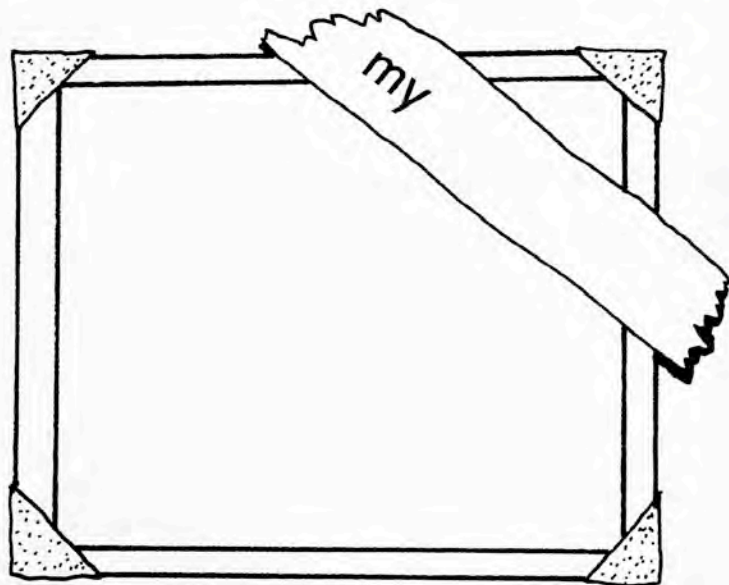
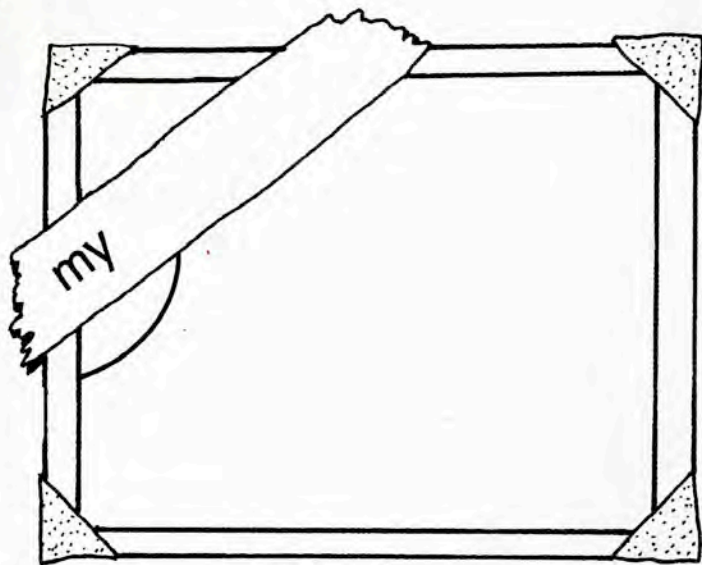

oo



Four empty boxes for writing the word.

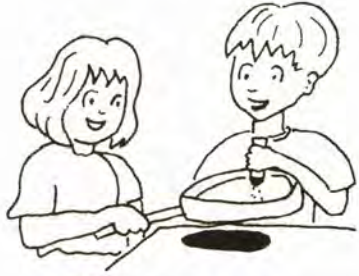

They are

Seven empty boxes for writing the words.



Three empty boxes for writing the word.

ou



Five empty boxes for writing the word.



Five empty boxes for writing the word.



Five empty boxes for writing the word.

er



Seven empty boxes for writing the word.



Seven empty boxes for writing the word.



Chuck's

Five empty boxes for writing the word.

th



Chuck's

Five empty boxes for writing the word.



Chuck's

Five empty boxes for writing the word.



Chuck's

Five empty boxes for writing the word.



Mark's _____



Chuck's _____



Ken's _____



Maria's _____



Max's _____

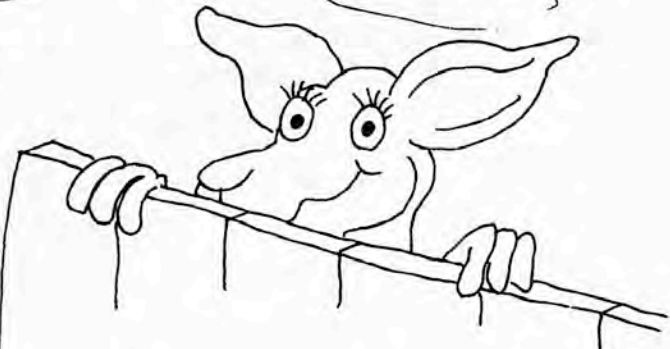

Kathy's _____